

ISSUE

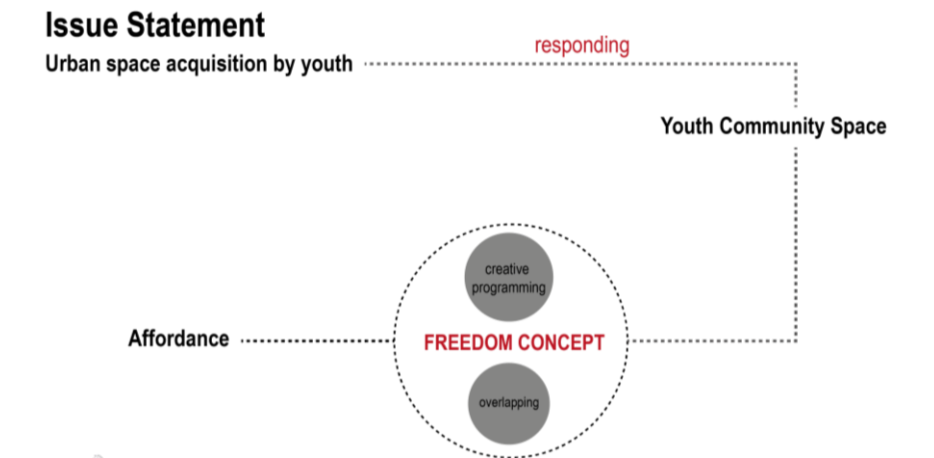

PROGRAMMING

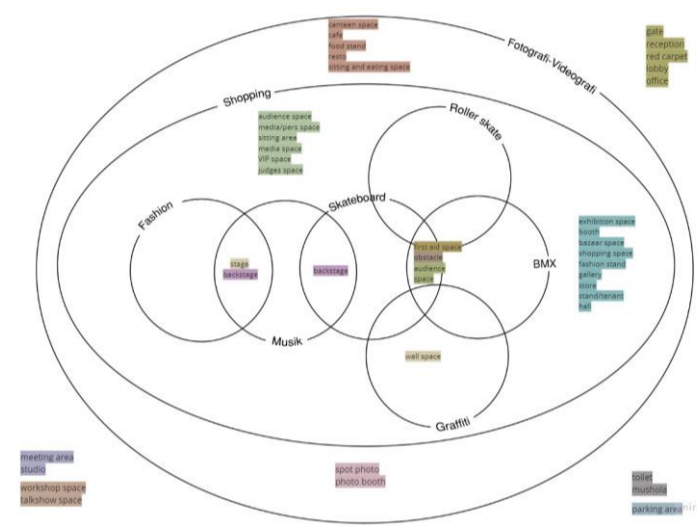

OVERALL PROGRAMMING

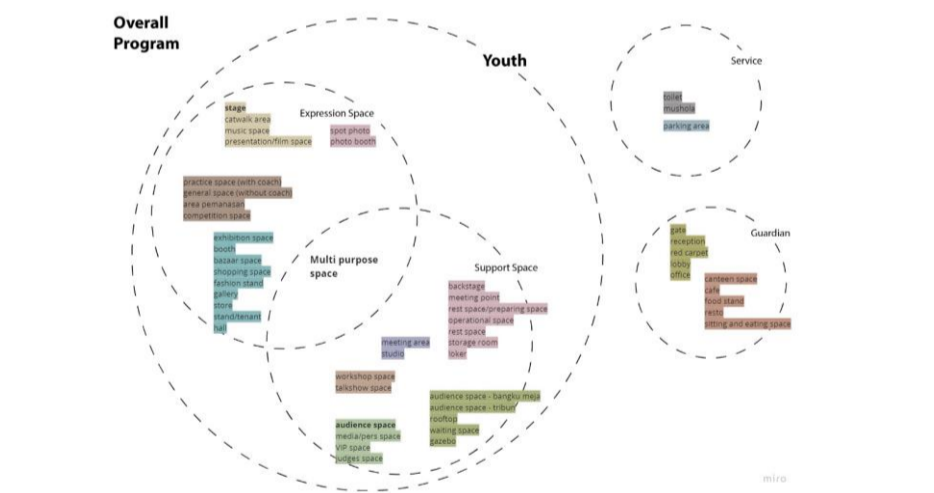

SEQUENCE DIAGRAMS

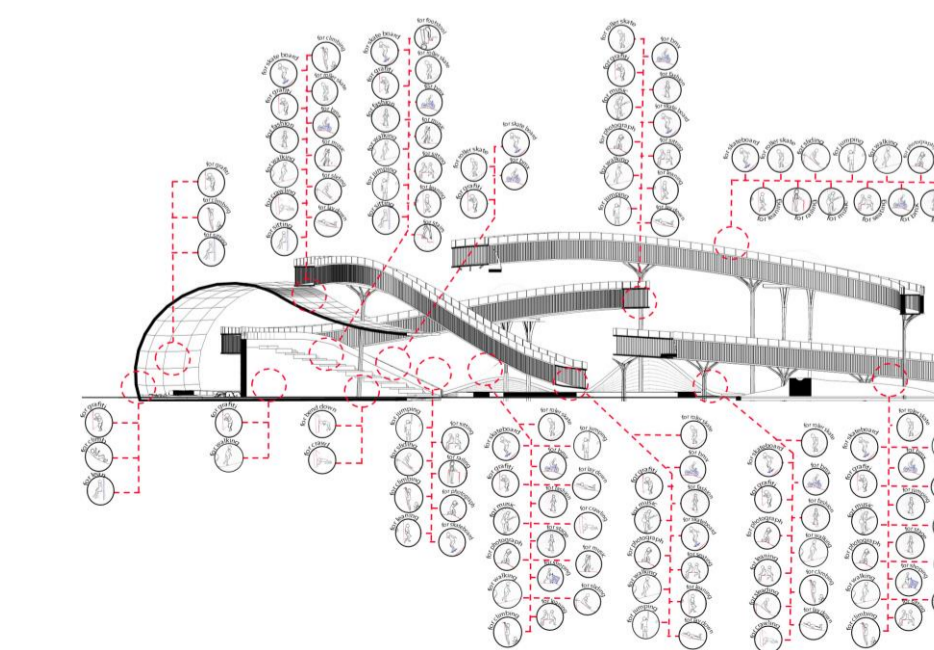

LITERATUR REVIEW

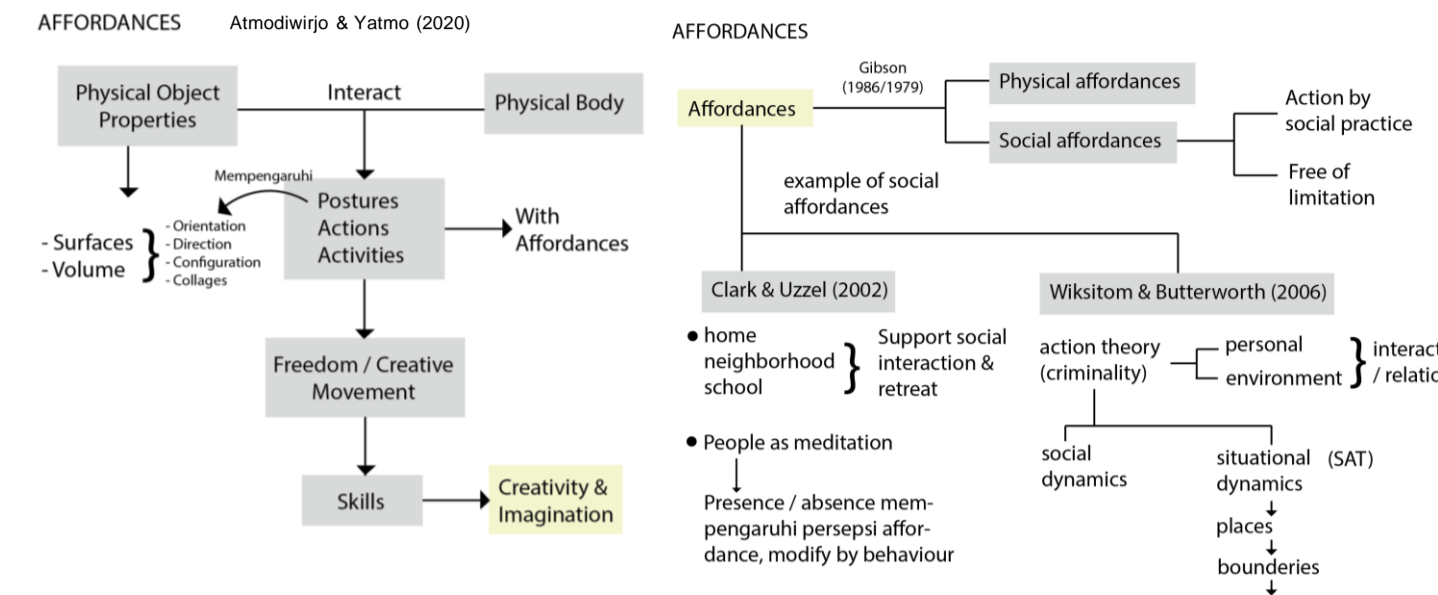

FORM AND MASSING

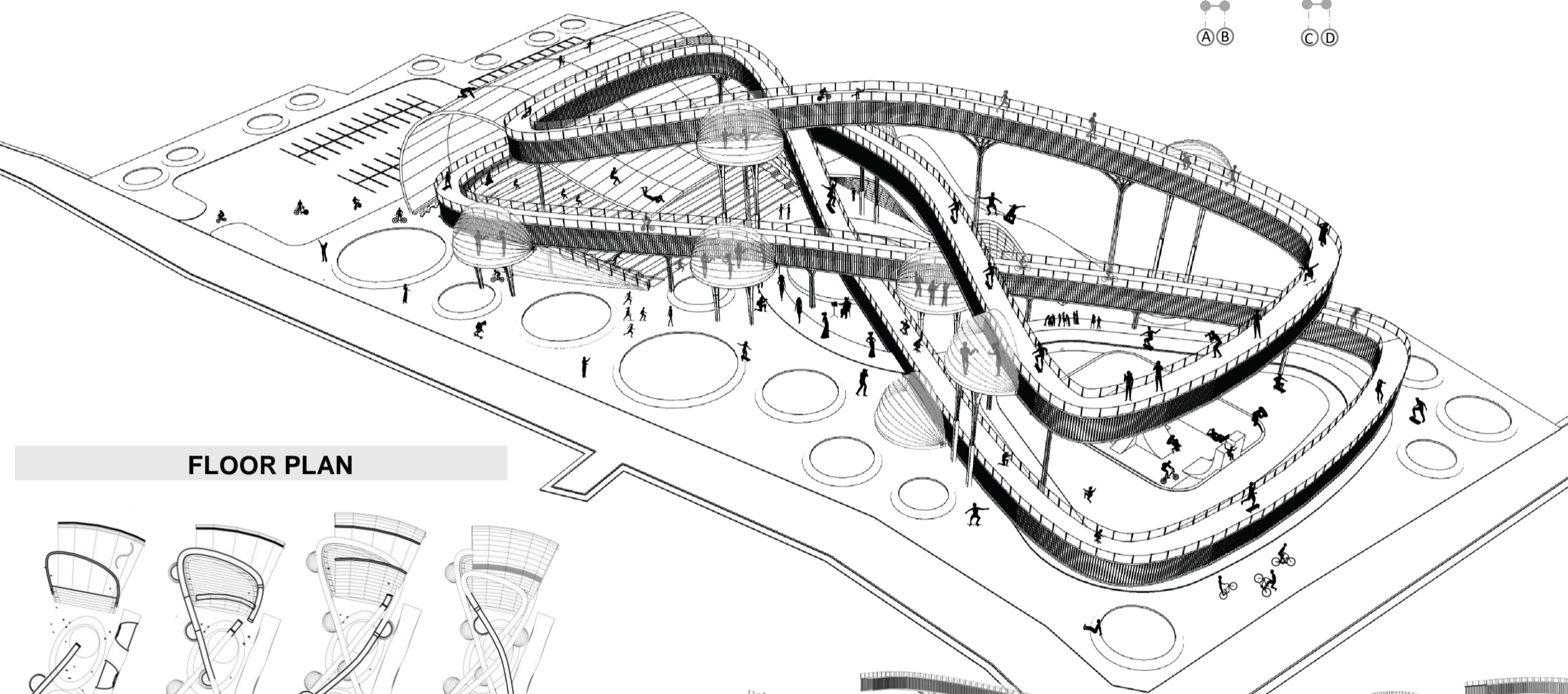

FLOOR PLAN

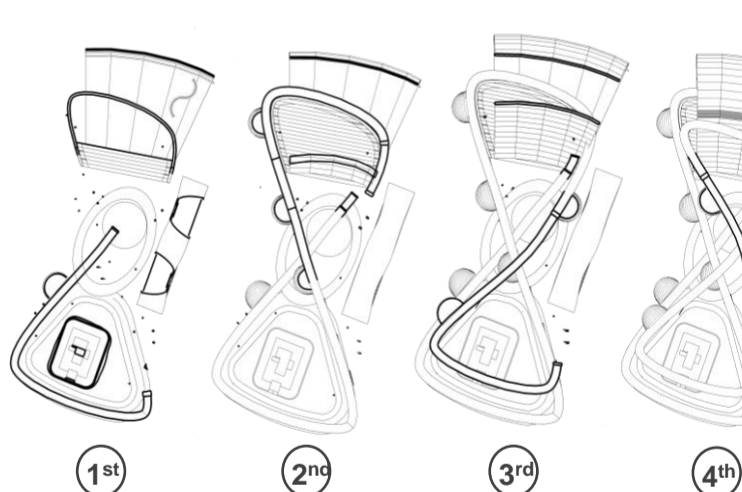

SECTIONS

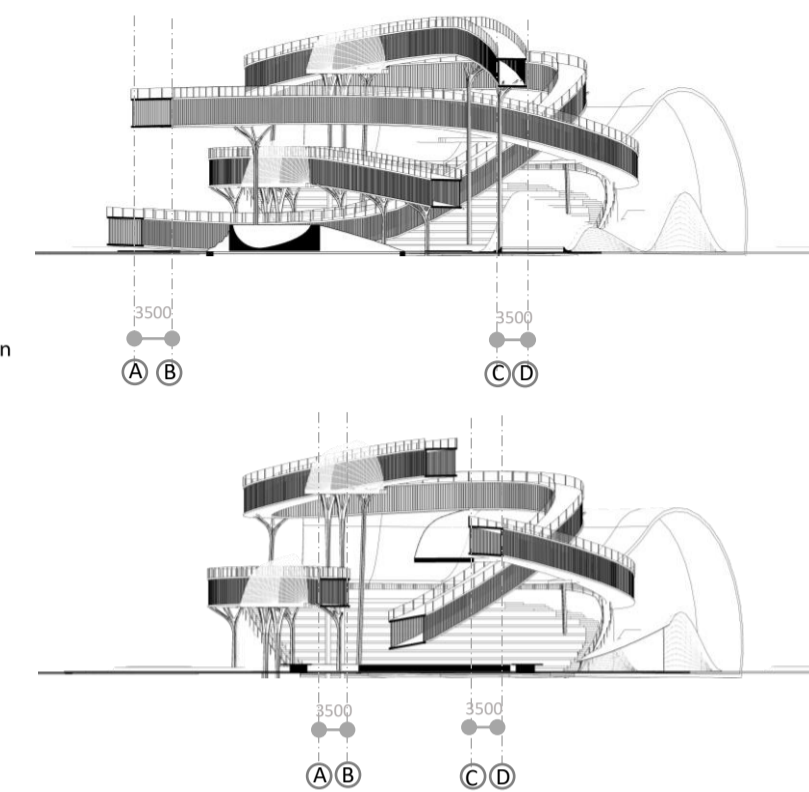

PERSPECTIVE



MASTERPLAN

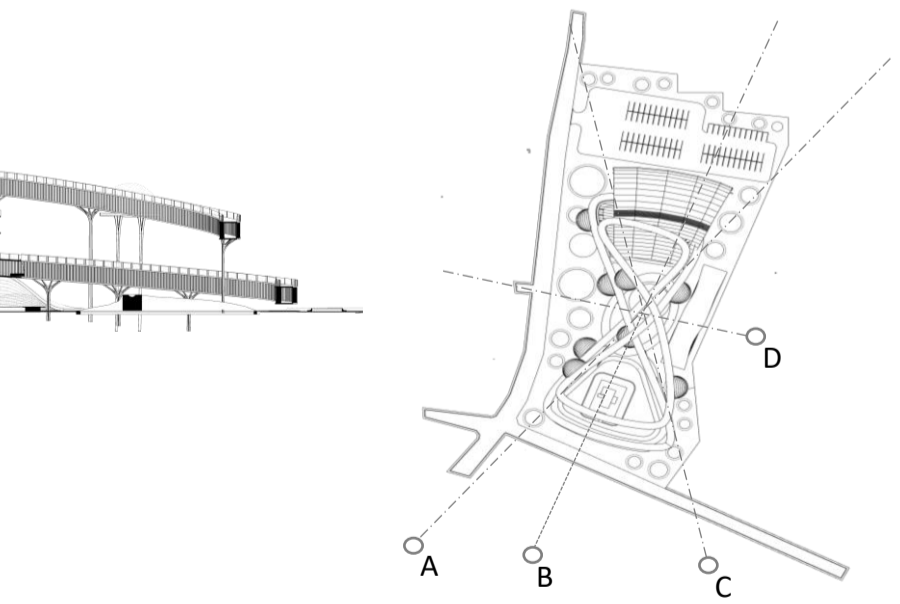

REFERENCES

Atmadiwirjo, P. (2014). Space affordances, adaptive responses and sensory integration by autistic children. *International Journal of Design*, 8(3), 35-47.

Atmadiwirjo & Yatmo (2020). *MOVING ONTO, INTO AND BETWEEN THE BOXES*

Gibson, J. J. 1986/1979. *The Ecological Approach to Visual Perception*. New Jersey. (originally published 1979) Erlbaum.

Jonathan Daly (2020) Superkilen: exploring the human–nonhuman relations of intercultural encounter, *Journal of Urban Design*, 25:1, 65-85, DOI: 10.1080/13574809.2019.1622409

Stoffregen, Thomas A.(2000) 'Affordances and Events', *Ecological Psychology*, 12: 1, 1 – 28, http://dx.doi.org/10.1207/S15326969ECO1201_1

Tim G. Townshend & Marion Roberts (2013) Affordances, Young People, Parks and Alcohol Consumption, *Journal of Urban Design*, 18:4, 494-516, DOI: 10.1080/13574809.2013.835696

Weston, L. M. (2010). Building cities for young people: Why we should design cities with preteens and young teens in mind. *Journal of Urban Design*, 15(3), 325– 334. <https://doi.org/10.1080/13574809.2010.487809>

Wooley, H., & Johns, R. (2001). Skateboarding: The city as a playground. *Journal of Urban Design*, 6(2), 211–230. <https://doi.org/10.1080/13574800120057845>

Woolley, H., Hazelwood, T., & Simkins, I. (2011). Don't skate here: Exclusion of skateboarders from urban civic spaces in three Northern Cities in England. *Journal of Urban Design*, 16(4), 471–487. <https://doi.org/10.1080/13574809.2011.585867>